

Installation Manual  
THM-0100 Setpoint Thermostat  
Version 1.041

The logo consists of the letters 'HBX' in a bold, black, sans-serif font. The letters are centered within a white rectangular area. This white area is flanked by two horizontal red bars, one above and one below the text. The entire logo is set against a background of a light beige color with a subtle, wavy, grid-like pattern that creates a sense of depth and perspective.

THM-0100

---

HBX Control Systems Inc.

# TABLE OF CONTENTS

<b>Introduction</b>	<b>Index</b>
Safety symbols and Warnings	Index
Receipt and Inspection	1
Description	1
Technical data and dimensions	1
<b>Programming THM-0100</b>	<b>2 - 9</b>
- Navigating the THM-0100	2
- Setting the THM-0100	2 - 4
- Special Functions	2 - 4
- Adjustments	5 - 9
<b>Installation and Wiring</b>	<b>10 - 12</b>
<b>Limited Warranty</b>	<b>13</b>

## INTRODUCTION

This manual will help with the installation, parameter setting, troubleshooting and general maintenance requirements for the Controller. To guarantee the safe and reliable operation of this Control, you must first read this manual in detail and take particular note to any and all warnings or caution directives prior to connecting to AC power.

Only suitably qualified individuals with formal training in electrical and HVAC controls should attempt the installation of this equipment. Incorrect wiring and installation will affect the warranty provided with this unit. Wiring must be completed in accordance with the codes and practices applicable to the jurisdiction for the actual installation.

The HBX THM-0100 is a microprocessor based controller and as such is not to be regarded as a safety (limit) control. Please consult and install the heating or cooling appliance in accordance with the manufacturer's recommendations.



## SAFETY SYMBOLS AND WARNINGS

### DRAWING REFERENCE

Refer to the specified electrical or mechanical drawing at the back of the manual.



### PRECAUTION

A measure taken in advance to prevent dangerous or an unpleasant event

# RECEIPT & INSPECTION

After receiving, inspect the unit for any possible physical damage that may have occurred during transportation. After unpacking the unit make sure the box contains:

- 1 x Universal sensor
- 1 x Thermostat THM-0100
- Instruction Manual

# DESCRIPTION

The HBX THM-0100 is a non-programmable thermostat designed for single stage heating or cooling incorporating a sophisticated P.I.D. algorithm. Using the included external sensor input allows for floor, remote room or outdoor temperature sensing. The THM-0100 can be used as a single setpoint control allowing for the operation of DHW (Digital Aquastat), pumps and other equipment.

Some features of the THM-0100 are:

- Backlit graphic display
- Push button keypad control
- User-friendly programming features
- Includes external sensor
- Integrated 2 Amp dry contacts

# TECHNICAL DATA AND DIMENSIONS

## Technical Data

- 1 x Dry Contact Output (120VAC 2 Amp Max)
- 1 x External Thermistor Input
- 1 x Power Contact: 24VAC or DC

**Dimensions:** 115 x 80 x 27.5mm

## ETL Listings:

- Meets CSA C22.2 No. 24
- Meets UL Standard 873
- ETL Control No. 3068143

**Storage:** +10C to +40C

**Languages:** English

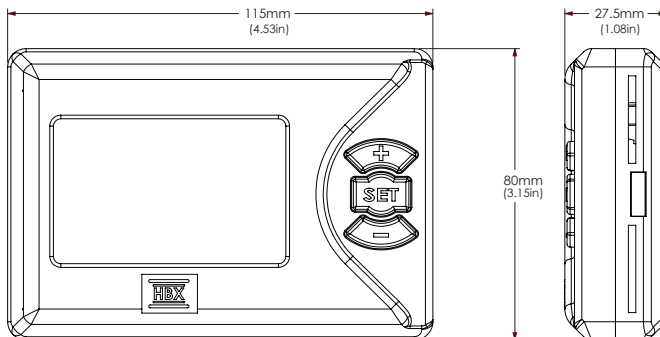

# PROGRAMMING THM-0100

## NAVIGATING THE THERMOSTAT

All programming steps within the thermostat are achieved by using the three buttons (and combinations thereof) located on the right-hand side of the thermostat.

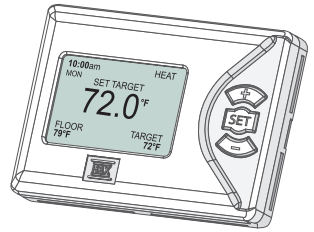

The + button is used to scroll up in menu screens and increase a value within specific options.

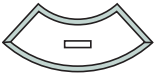

The - button is used to scroll down in menu screens and decrease a value within specific options.

Pressing the + or - button on their own for 2 seconds while viewing the main “**Status Screen**” will allow you to quickly adjust your target temperature. Once you have reached the desired target temperature by using the + and - buttons, waiting five seconds will return the thermostat to the initial “**Status Screen**” mode.

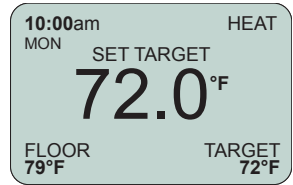

## SETTING THE THERMOSTAT

### *Special Functions*

Enter the “**Special Functions**” screen by holding down the + and - buttons simultaneously for 5 seconds (from the “**Status Screen**”). To select the desired option, use the + and - buttons to toggle and the **set** button to select.

**1) Type** - Select between Heating, Cooling, and Setpoint modes.

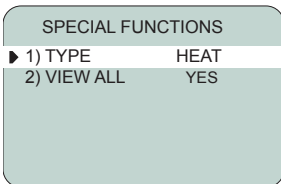

### ► Heat Function

Select the “Heat Function” for applications using a single heating source.



See diagram 1 for wiring examples.

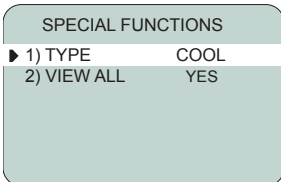

### ► Cool Function

Select the “Cool Function” for applications using a single cooling source.



See diagram 2 for wiring example.

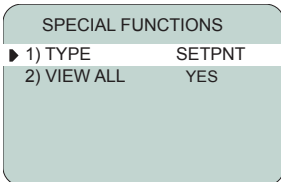

### ► Setpoint Function

Select the “Setpoint Function” for applications using pumps, fancoils and other equipment.



See diagram 3 for wiring example.

## SPECIAL FUNCTIONS

- ▶ 1) TYPE COOL
- 2) VIEW ALL YES

## ▶ View All/ Hide All

Use this setting to control the information displayed on the Status Screen.

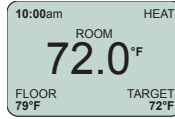

"View All" = Yes

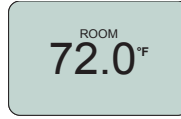

"View All" = No

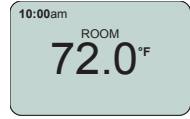

"View All" = Time

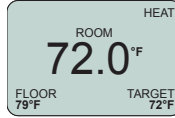

"View All" = Target

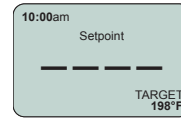

No external sensor installed

## Adjustments

### THE ADJUSTMENT SCREEN

Holding down the **set** button for 2 seconds while viewing the "Status Screen" will take you into the "Adjustment Screen" for the respective thermostat modes (Heating, Cooling or Setpoint).



Once you are in the desired options screen, use the + and - button to scroll up and down. Press down the **set** button to choose the option (the arrow to the left of your chosen option will turn black when you have selected a specific step), then the + and - buttons to adjust the value. Press the SET button to scroll between options again.

#### HEATING ADJUSTMENT

- ▶ 1) ROOM TEMP 70°F
- 2) MODE ROOM
- 3) SENSOR 1 FLOOR
- 4) C OR F °F
- 5) BACKLIGHT OFF
- 6) TIME 1:05am

#### COOLING ADJUSTMENT

- ▶ 1) ROOM 70°F
- 2) SENSOR 1 FLOOR
- 3) C OR F °F
- 4) BACKLIGHT OFF
- 5) TIME 1:05am

#### SETPOINT ADJUSTMENT

- ▶ 1) SETPOINT 130°F
- 2) MODE HEAT
- 3) DIFF 20°F
- 4) LAG TIME 0S
- 5) C OR F °F
- 6) TIME 1:05am

## HEATING ADJUSTMENT SETTINGS

The Heating Adjustment screen is applicable to the Heating option, selected in the special functions screen. Enter the Heating Adjustment screen by holding the SET button after selecting "Heat". (See Page 2)

### HEATING ADJUSTMENT

▶ 1) ROOM TEMP	70°F
2) MODE	ROOM
3) SENSOR 1	FLOOR
4) C OR F	°F
5) BACKLIGHT	OFF
6) TIME	1:05am

#### ▶ Room Temperature

Set this value to the desired room target.  
*Range from 32°F to 200°F*

## MODE OPTIONS

This option allows you to select between Room, Floor or Dual

### Room Mode

### HEATING ADJUSTMENT

1) ROOM TEMP	70°F
▶ 2) MODE	ROOM
3) SENSOR 1	NONE
4) C OR F	°F
5) BACKLIGHT	OFF
6) TIME	1:05am

#### ▶ Room Mode

Sensor temperature providing feedback for the specific room or zone being controlled by the thermostat.

### HEATING ADJUSTMENT

1) ROOM TEMP	70°F
2) MODE	ROOM
▶ 3) SENSOR 1	NONE
4) C OR F	°F
5) BACKLIGHT	OFF
6) TIME	1:05am

#### ▶ Sensor 1 (Only Applies in Room Mode)

Enable the feedback sensor as None, Room, Floor, Outdoor or Room Average in Floor mode

**None** - No external sensor is connected to the Thermostat.

**Room** - The external sensor is used to control the room temperature.

**Floor** - The external sensor is used to display the floor temperature.

**Outdoor** - The external sensor is used to display the outdoor temperature.

**Room Average** - This setting averages the external sensor and internal sensor to control the room temperature.

## Floor Mode

### HEATING ADJUSTMENT

- 1) ROOM TEMP 70°F
- 2) MODE FLOOR
- ▶ 3) DIFF 20°F
- 4) C OR F °F
- 5) BACKLIGHT OFF
- 6) TIME 1:05am

### ▶ Floor Mode

Sensor temperature providing feedback from the floor surface to the thermostat. This mode will run the thermostat on floor temperature only.

### HEATING ADJUSTMENT

- 1) ROOM TEMP 70°F
- 2) MODE FLOOR
- ▶ 3) DIFF 20°F
- 4) C OR F °F
- 5) BACKLIGHT OFF
- 6) TIME 1:05am

### ▶ Differential (Only Applies in Floor Mode)

When in floor mode, the differential option must be set to define the temperature margin that will instigate a heat demand.

## Dual Mode

### HEATING ADJUSTMENT

- 1) ROOM TEMP 70°F
- ▶ 2) MODE DUAL
- 3) FLOOR MAX 85°F
- 4) FLOOR MIN 65°F
- 5) C OR F °F
- 6) TIME 1:05am

### ▶ Dual Mode

Sensor temperature providing feedback for both the air temperature and floor sensor temperatures.

### HEATING ADJUSTMENT

- 1) ROOM TEMP 70°F
- 2) MODE DUAL
- ▶ 3) FLOOR MAX 85°F
- 4) FLOOR MIN 65°F
- 5) C OR F °F
- 6) TIME 1:05am

### ▶ Floor Maximum (Only Applies in Dual Mode)

The thermostat will not allow the temperature in the floor to go above this value, protecting the integrity of the floor covering.

### HEATING ADJUSTMENT

- 1) ROOM TEMP 70°F
- 2) MODE DUAL
- 3) FLOOR MAX 85°F
- ▶ 4) FLOOR MIN 65°F
- 5) C OR F °F
- 6) TIME 1:05am

### ▶ Floor Minimum (Only Applies in Dual Mode)

The thermostat will not allow the temperature in the floor to go below this value, protecting the integrity of the floor covering.

## Additional Settings

### HEATING ADJUSTMENT

- 1) ROOM TEMP 70°F
- 2) MODE ROOM
- 3) SENSOR 1 NONE
- ▶ 4) C OR F °F
- 5) BACKLIGHT OFF
- 6) TIME 1:05am

### ▶ Celsius or Fahrenheit

Change the values in the thermostat to display either the Celsius or Fahrenheit scale.

#### HEATING ADJUSTMENT

- 1) ROOM TEMP 70°F
- 2) MODE ROOM
- 3) SENSOR 1 NONE
- 4) C OR F °F
- ▶ 5) BACKLIGHT OFF
- 6) TIME 1:05am

#### ▶ Backlight

Toggling this option will turn the backlight feature either on or off. Allow approximately 60 seconds for the backlight to power off.

#### HEATING ADJUSTMENT

- 1) ROOM TEMP 70°F
- 2) MODE ROOM
- 3) SENSOR 1 NONE
- 4) C OR F °F
- 5) BACKLIGHT OFF
- ▶ 6) TIME 1:05am

#### ▶ Time

Set the time for your appropriate time zone.

## COOLING ADJUSTMENT SETTINGS

The Cooling Adjustment screen is applicable to the Cooling option, selected in the special functions screen. Enter the Cooling Adjustment screen by holding the SET button after selecting "Cool". (See Page 2)

#### COOLING ADJUSTMENT

- ▶ 1) ROOM 70°F
- 2) SENSOR 1 FLOOR
- 3) C OR F °F
- 4) BACKLIGHT OFF
- 5) TIME 1:05am

#### ▶ Room Temperature

Set this value to the desired room target.  
*Range from 32°F to 200°F*

#### COOLING ADJUSTMENT

- 1) ROOM 70°F
- ▶ 2) SENSOR 1 FLOOR
- 3) C OR F °F
- 4) BACKLIGHT OFF
- 5) TIME 1:05am

#### ▶ Sensor 1

Enable the feedback sensor as None, Room, Floor, Outdoor or Room Average in Floor mode

**None** - No external sensor is connected to the Thermostat.

**Room** - The external sensor is used to control the room temperature.

**Floor** - The external sensor is used to display the floor temperature.

**Outdoor** - The external sensor is used to display the outdoor temperature.

**Room Average** - This setting averages the external sensor and internal sensor to control the room temperature.



#### COOLING ADJUSTMENT

- 1) ROOM 70°F
- 2) SENSOR 1 FLOOR
- ▶ 3) C OR F °F
- 4) BACKLIGHT OFF
- 5) TIME 1:05am

#### ▶ Celsius or Fahrenheit

Change the values in the thermostat to display either the Celsius or Fahrenheit scale.

#### COOLING ADJUSTMENT

- 1) ROOM 70°F
- 2) SENSOR 1 FLOOR
- 3) C OR F °F
- ▶ 4) BACKLIGHT OFF
- 5) TIME 1:05am

#### ▶ Backlight

Toggling this option will turn the backlight feature either on or off. Allow approximately 60 seconds for the backlight to power off.

#### COOLING ADJUSTMENT

- 1) ROOM 70°F
- 2) SENSOR 1 FLOOR
- 3) C OR F °F
- 4) BACKLIGHT OFF
- ▶ 5) TIME 1:05am

#### ▶ Time

Set the time for your appropriate time zone.

## SETPOINT ADJUSTMENT SETTINGS

The Setpoint Adjustment screen is applicable to the Setpoint option, selected in the special functions screen. Enter the Setpoint Adjustment screen by holding the SET button after selecting "Setpnt". (See Page 2)

#### SETPOINT ADJUSTMENT

- ▶ 1) SETPOINT 130°F
- 2) MODE HEAT
- 3) DIFF 20°F
- 4) LAG TIME 0S
- 5) C OR F °F
- 6) TIME 1:05am

#### ▶ Setpoint

Set this value to the desired setpoint target.

#### SETPOINT ADJUSTMENT

- 1) SETPOINT 130°F
- ▶ 2) MODE HEAT
- 3) DIFF 20°F
- 4) LAG TIME 0S
- 5) C OR F °F
- 6) TIME 1:05am

#### ▶ Mode

Select between Heat mode or Cool mode.

#### SETPOINT ADJUSTMENT

- 1) SETPOINT 130°F
- 2) MODE HEAT
- ▶ 3) DIFF 20°F
- 4) LAG TIME 0S
- 5) C OR F °F
- 6) TIME 1:05am

#### ▶ Differential

A differential of 10° is 5° above the setpoint and 5° below the setpoint.

SETPOINT ADJUSTMENT	
1) SETPOINT	130°F
2) MODE	HEAT
3) DIFF	20°F
▶ 4) LAG TIME	0S
5) C OR F	°F
6) TIME	1:05am

### ▶ Lag Time

Set the desired lag time interval. This is a time delay before control turns on.

SETPOINT ADJUSTMENT	
1) SETPOINT	130°F
2) MODE	HEAT
3) DIFF	20°F
4) LAG TIME	0S
▶ 5) C OR F	°F
6) TIME	1:05am

### ▶ Celsius or Fahrenheit

Set the display value as either Celsius or Fahrenheit.

SETPOINT ADJUSTMENT	
1) SETPOINT	130°F
2) MODE	HEAT
3) DIFF	20°F
4) LAG TIME	0S
5) C OR F	°F
▶ 6) TIME	1:05am

### ▶ Time

Set the time for your appropriate time zone.

## MOUNTING AND WIRING INSTRUCTIONS

### Mounting Guide

Once you have wired the terminal block, the THM-0100 can be mounted on the desired interior wall. The unit should be placed in an area clear of drafts or other heating or cooling sources which may influence the temperature reading of the thermostat.

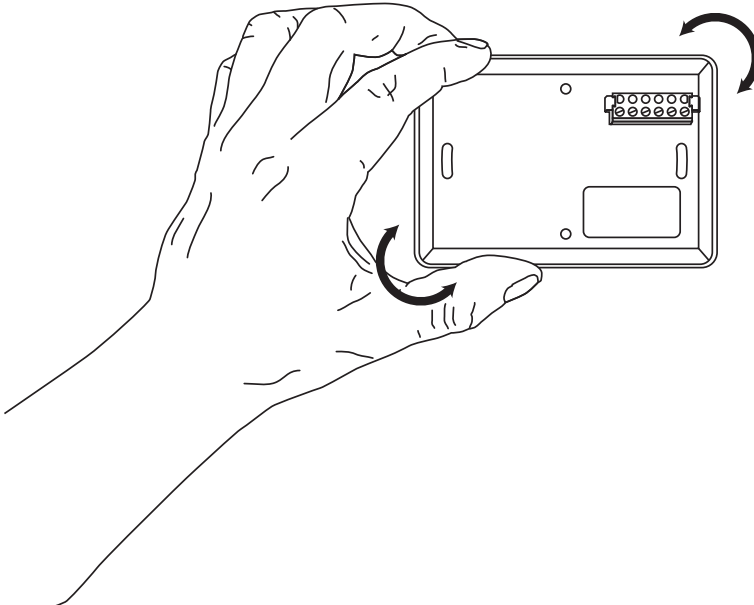

# WIRING DIAGRAMS

## Wiring Guide

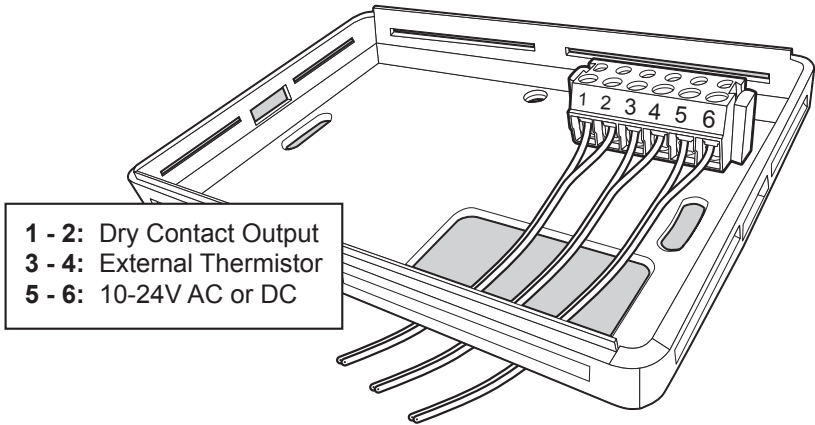

## 1. HEATING

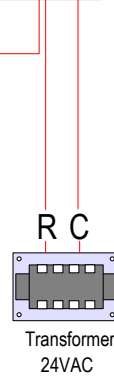
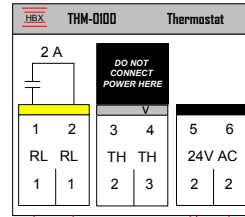
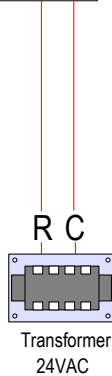
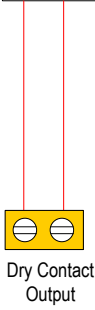
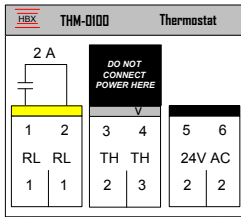

## 2. COOLING

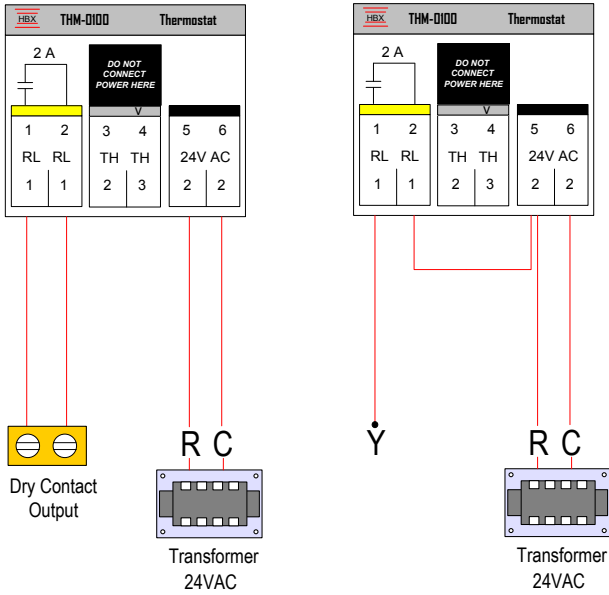

## 3. SETPOINT

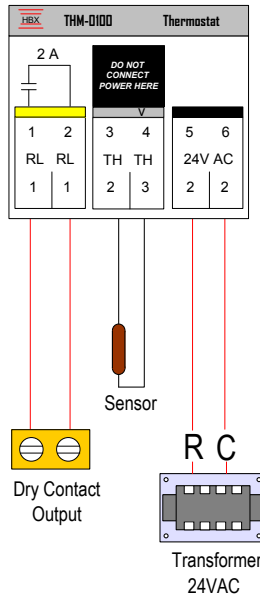





## LIMITED WARRANTY

HBX Controls warrants each of its products to be free from defects in workmanship and materials under normal use and service for a period of 24 months from date of manufacture or 12 months from date of purchase from an HBX Authorized Dealer, if within the above documented period after date of manufacture.

If the product proves to be defective within the applicable warranty period, HBX on its sole discretion will repair or replace said product. Replacement product may be new or refurbished of equivalent or better specifications, relative to the defective product. Replacement product need not be of identical design or model. Any repair or replacement product pursuant to this warranty shall be warranted for not less than 90 days from date of such repair, irrespective of any earlier expiration of original warranty period. When HBX provides replacement, the defective product becomes the property of HBX Controls.

Warranty Service, within the applicable warranty period, may be obtained by contacting your nearest HBX Controls office via the original Authorized Agent and requesting a Return Material Authorization Number (RMA #). Proof of purchase in the form a dated invoice/receipt must be provided to expedite the issuance of a Factory RMA.

After an RMA number has been issued, the defective product must be packaged securely in the original or other suitable shipping package to ensure that it will not be damaged in transit. The RMA number must be visible on the outside of the package and a copy included inside the package. The package must be mailed or otherwise shipped back to HBX with all costs of mailing/shipping/insurance prepaid by the warranty claimant.

Any package/s returned to HBX without an approved and visible RMA number will be rejected and shipped back to purchaser at purchaser's expense. HBX reserves the right, if deemed necessary, to charge a reasonable levy for costs incurred, additional to mailing or shipping costs.

## LIMITATION OF WARRANTIES

If the HBX product does not operate as warranted above the purchasers sole remedy shall be, at HBX's option, repair or replacement. The foregoing warranties and remedies are exclusive and in lieu of all other warranties, expressed or implied, either in fact or by operation of law, statutory or otherwise, including warranties of merchantability and fitness for a particular purpose/application. HBX neither assumes nor authorizes any other person to assume for it any other liability in connection with the sale, installation maintenance or use of HBX Controls products.

HBX shall not be liable under this warranty; if its testing and examination discloses that the alleged defect in the product does not exist or was caused by the purchasers or third persons misuse, neglect, improper installation or testing, unauthorized attempts to repair or any other cause beyond the range of intended use, or by accident, fire, lightning or other hazard.

## LIMITATION OF LIABILITY

In no event will HBX be liable for any damages, including loss of data, loss of profits, costs of cover or other incidental, consequential or indirect damages arising out of the installation, maintenance, commissioning, performance, failure or interruption of an HBX product, however caused and on any theory of liability. This limitation will apply even if HBX has been advised of the possibility of such damage.

## LOCAL LAW

This limited warranty statement gives the purchaser specific legal rights. The purchaser may also have other rights which vary from state to state in the United States, from Province to Province in Canada and from Country to Country elsewhere in the world.

To the extent this Limited Warranty Statement is inconsistent with local law, this statement shall be deemed modified to be consistent with such local law. Under such local law, certain disclaimers and limitations of this statement may not apply to the purchaser. For example, some states in the United States, as well as some governments outside the United States (including Canadian Provinces), may: Preclude the disclaimers and limitations in this statement from limiting the statutory rights of a consumer (e.g. United Kingdom);

Otherwise restrict the ability of a manufacturer to enforce such disclaimers or limitations; or grant the purchaser additional warranty rights which the manufacturer cannot disclaim, or not allow limitations on the duration of implied warranties.

Phone: +1 (403) 720-0029 Fax: +1 (403) 720-0054  
Email: [info@hbxcontrols.com](mailto:info@hbxcontrols.com) Web: [www.hbxcontrols.com](http://www.hbxcontrols.com)

